

FEIDER

MACHINES



PETROL LAWN MOWER

FTDT5124VS

USER GUIDE

CAUTION: Read the instructions before using the machine!

CONTENTS

1. INTENDED USE.....	3
2. SAFETY INSTRUCTIONS.....	3
3. YOUR PRODUCT.....	8
4. ASSEMBLY.....	9
5. FILLING FUEL AND OIL TANK.....	14
6. OPERATION	15
7. MAINTENANCE AND STORAGE.....	18
8. TROUBLESHOOTING.....	22
9. DECLARATION OF CONFORMITY.....	23
10. WARRANTY.....	24
11. PRODUCT FAILURE.....	25
12. WARRANTY EXCLUSIONS.....	26

1. INTENDED USE

This equipment is intended for mowing lawns. It is not suitable for commercial use. Any use other than specifically permitted in this instruction may result in damage or injury. This equipment is intended for use by adults. Children or other people who are unfamiliar with the operating instructions must not operate this equipment.

2. SAFETY INSTRUCTIONS

Instructions

- Read the instructions carefully. Be familiar with the controls and proper use of the equipment.
- Never allow children to use this mower. If the mower is given to another person, also give them this manual. Also make sure that this person only uses this device after receiving the necessary instructions. Local laws may restrict the age of the user.
- Never mow while people, especially children, or animals are nearby.
- Keep in mind that the operator or user is responsible for accidents or risks that may occur to other persons or their property.
- If necessary, have training with an experienced person in order to use this tool in a safe way.

Preparation

- During mowing, always wear safety shoes and long pants. Do not use the equipment barefoot or wearing open sandals.
- Wear personal protective equipment including at least: protection clothing, gloves, slip-resistant foot protection, mask, eye and hearing protection.
- Carefully inspect the area where equipment is being used by removing all objects that may be affected by the machine.
- **WARNING** - Gasoline is extremely flammable.
 - Add fuel before starting. Do not remove the fuel tank cap while the machine is running or when it is hot.
 - If the fuel has spilled or leaked, do not attempt to start the machine but move the machine away from the leakage area and avoid creating a source of ignition until the gasoline vapors have dissipated.
 - Refuel only outside and do not smoke during refueling.
 - Store fuel in tanks specifically designated for this purpose.
 - Replace a defective fuel tank or gasoline cap before using the machine.
- Replace defective mufflers.
- Before use, always inspect visually that the blades, blade assembly and blade lock are not worn or damaged. Replace blades and blade assemblies that are not in good condition to maintain balance. Contact the manufacturer or your dealer in order to have a list of recommended blades. Non-recommended blades can give a risk of malfunctions, injuries and accidents.
- The blades must be balanced to ensure proper operation and to be able to work safely.

Operation

- Do not use the machine in a confined space or hazardous carbon monoxide emissions can be accumulated and cause injury.
- Mow only under daylight or under good artificial light. Good visibility must always be ensured.
- Avoid using the equipment on greasy grass, where possible.
- Always be careful and wear suitable footwear when walking on slopes.
- Walk, never run.
- For lawn mowers, mow across slopes, never from top to bottom.

- Exercise extreme caution when changing direction on slopes.
- Stop the blades if the mower is to be tilted during transport when crossing surfaces other than grass, and when transporting the mower due to the area to be mowed.
- Do not mow on steep slopes.
- Use extreme caution when tipping or pulling the mower towards you.
- Never use the mower with defective guards, or without safety devices such as baffles and or collection bins, which are not in place.
- Do not change the engine configuration or increase the speed.
- For starting, disengage all blades, the gears must be in neutral, the traction control lever must be released. Set foot well away from the blades.
- Before starting the engine or engaging the blades or traction, carefully read and understand all instructions.
- Do not tilt the mower when starting the machine or turn on the engine, unless the mower needs to be tilted for starting. In this case, do not tilt it more than necessary and lift only the part that is furthest away from the user.
- Do not start the machine by standing in front of the ejection.
- Do not place hands or feet near or under rotating parts. Keep clean the mouth of the grass extractor.
- Never take or carry the mower while the machine is running.
- Stop the machine, disconnect the spark plug from the spark socket:
 - Before cleaning or unclogging the grass extractor.
 - Before checking, cleaning, and working on the mower.
 - After hitting an object. Inspect the mower for damage and repair before re-using the mower.
 - If the mower begins to vibrate abnormally, stop the engine immediately and check according to previous recommendations.
- The controls must be always checked if they are functioning correctly. In case of malfunction, do not use the tool and bring to a service agent for inspection.
- Stop the engine immediately:
 - Every time you leave the craft.
 - Before refueling.
- When the tool is stopped, park it in a safe place.
- Move slowly when moving.
- The lawnmower should not be used in slopes and near drop-offs, ditches or embankments; if the tool must be used in these kinds of emplacements, take an extreme precaution and operate carefully the tool.
- The lawnmower safety systems or features shall not be tampered with or disabled;
- The operator should not alter or tamper with any sealed adjustments for the engine speed control.

Maintenance and storage

- Do servicing and replacement tasks with the engine shut off, including the need to keep the lawnmower in good working condition.
- Check and tighten all bolts and screws to ensure that the equipment is in safe operating condition.
- Never keep the mower with gasoline in the tank in a building or vapors can cause a bright flame or spark.
- Allow the machine to cool before storing it in an enclosed area.
- To reduce the risk of fire, keep the machine clean without grass, without grease, the muffler and the engine cools, disconnect the battery if necessary and empty the fuel tank
- Check the grass catcher frequently, its condition or deterioration.

- Replace worn and damaged parts for safety.
- If the fuel tank is to be drained, it must be made outdoors.

Special safety instructions

- In case of lack of knowledge or first use of this product, we recommend that you have a formation/ training with a professional or an experienced person.
- Always use the mower with its pick-up bag and / or deflector in the intended position.
- Switch off the engine before emptying the pick-up bag or before changing the cutting height.
- While the engine is running, never put your hands or feet under the mower or under the grass ejection area.
- Before mowing, remove all foreign objects (such as stones, toys, sticks and wires) from the grass that can be propelled by the machine.
- Keep children and pets at a safe distance while using the mower.
- Never lift the mower when the engine starts.
- Alcohol, drug, as well as illness, fever and fatigue affect your ability to respond. Do not use this tool in such circumstances.
- Never change the rated speed of the engine.
- Never lift or carry the tool while the engine is running.
- Before mowing, install the collection bag in its intended position.
- Do not use the mower in the event of rain or when the grass is wet.
- Never lift the rear of the mower when starting the engine and never place your hands or feet under the mower deck or in the rear ejection port while the engine is running.
- Turn off the engine and remove the spark plug cap in the following cases:
 - Before operating under the mower deck or near the ejection opening.
 - Before any maintenance, repair or verification.
 - Before transporting, lifting or storing the mower.
 - If you leave the mower unattended or change the cutting height.
 - To remove and empty the collection bag.
- After striking a foreign object, turn off the engine and carefully inspect the mower for damage. Take the lawnmower to an authorized service center for repair if necessary.
- If the mower vibrates abnormally, try to understand the reason and bring your lawnmower to an authorized repair center.
- Regularly check that the bolts, nuts and screws are properly tightened for safe use of the mower.
- Do not use the tool where there is a risk of lightning.
- Use the tool on daylight or under a good lighting. Always keep bystanders away.
- Warning: Take an extreme precaution when operating the lawnmower in slopes and near drop-offs, ditches or embankments; always be sure of your footing and stay in alert.
- Warning: do not use of the unit while being tired, ill or under influence of alcohol or other drugs;
- Park safely the tool before leaving it. The tool must be switched off.
- Warning: be careful about exhaust gas. Do not inhale them and do not expose people to these gases.
- To avoid health issues, limit the time of operation. Take enough rest. Exposure to noise and vibrate can have bad consequences on health.
- WARNING: There is a danger about moving blade assemblies. Always handle blades when they are in a complete stop and wear protective gloves.
- The blade stopping device must always work. If the blade does not stop after stopping the machine and the devices are damaged, the machine should be taken to a qualified service for inspection.

Fuel Handling

Use caution when handling fuels. They are flammable and the vapors are explosive.

Use only an approved container.

Never remove the fuel cap or add fuel while the machine is on. Turn off the unit and allow the engine and exhaust components to cool down before refueling.

Do not smoke.

Never refuel inside a room.

Never store the tool and the fuel tank indoors where there is a naked flame, such as near a water heater.

If fuel has spilled, do not attempt to start the machine, but move it away from the spill before starting to use it. Please clean up any spills.

Replace and tighten the fuel tank cap after refueling.

Follow strictly the instructions in this manual for filling the tool with fuel.

During maintenance and storage

Switch off the tool and wait until it stops completely. Make sure that all moving parts are stopped.

Allow the machine to cool before performing inspection, adjustments, maintenance, servicing and storage.

Store the tool where fuel vapor will not reach a flame or spark.

When transporting and storing the tool, always use a protection device to avoid fuel spillage, accidents and injuries.

Residual risks

Even if you use this product in compliance with all safety requirements, the potential risks of injury and damage remain. The following hazards may arise in the structure and design of this product:

There are risks of injury and property damage due to attachments or broken the sudden impact of hidden objects when using cutting.

There are risks of injuries and accidents caused by flying objects.

Prolonged use of this product exposes the operator to vibrations and can produce so-called "white finger" disease. To reduce the risk, wear gloves and keep your hands warm.



If any of the symptoms of "white finger syndrome" occur, seek immediate medical attention.











Symptoms of "white finger" include numbness, loss of sensitivity, tingling, pain, loss of strength, colour changes or skin condition. These symptoms usually appear on the fingers, hands or wrists.

Risk increases at low temperatures.

A long exposition to noise can affect the health of the operator. A hearing protection must be always used when operating the tool. The operation of the tool must be limited, and some rest must be taken between two sessions (e.g. 10min of operation and 20min of rest).

SYMBOLS

	WARNING-To reduce the risk of injury, read this instruction handbook before use.
	Risk of injury from thrown or flying object! Keep bystanders away from equipment.

	<p>Danger! Keep your hands and feet away from the cutting element.</p>
	<p>Toxic fumes; don't operate inside house.</p>
	<p>Fuel is flammable, keep fire away. Do not add fuel with running machine.</p>
	<p>Caution – hot surface.</p>
	<p>Unplug the spark plug before maintenance and repair. Read the instruction manual.</p>
	<p>Wearing eye & ear protection.</p>
	<p>Add oil slowly. Do not overfill.</p>
	<p>Release switch handle to stop the engine.</p>
	<p>Pull on the self-propelled lever to drive wheel on.</p>
	<p>Keep hands away from the running blade.</p>
	<p>Guarantee sound power level.</p>

3. YOUR PRODUCT

3.1 DESCRIPTION



1.	Self-propelled lever	7.	Steel Deck	13.	Hook for recoil start rope
2.	Engine control lever	8.	Side discharge chute	14.	Recoil start handle
3.	Superior handle	9.	Rear wheel	15.	Primer bulb
4.	Inferior handle	10.	Height adjusting lever	16.	Clean interface
5.	Engine	11.	Grass catcher	17.	Cable clamp
6.	Front wheel	12.	Tools box	18.	Fuel tank

3.2 TECHNICAL DATA

Model	FTDT5124VS
Engine	DV224 OHV
Engine Type	Air cooled, 4stroke OHV
Displacement	224cm ³
Starting style	Recoil
Rated Engine power	4,4kW
Rated engine speed	2800 min ⁻¹
Cutting width	50,8cm
Motion type	Self-propelled
Volume of the collection bag	62L
Net Weight	33,65 kg
Fuel tank capacity	1200 ml
Oil tank capacity	400 ml
Cutting Height:	25-75mm (8 positions for height adjustment)
Wheel diameter	177mm(7") front /254mm (10") rear
Blade	Builder Straight Blade
Sound pressure level	L _{pA} : 84.4dB(A) K=3.0 dB(A)
Sound power level	L _{wA} : 94.5dB(A) K= 1.89 dB(A)
Guaranteed Sound Power Level	98 dB(A)
Vibration value	Max 5.5m/s ² , K=2.2m/s ²

4. ASSEMBLY

4.1 ASSEMBLY OF THE HANDLE

1) Take out the machine from carton box and check all accessories completely or not.(Fig.1,2,3)



Fig.1



Fig.2



Fig.3

- 2) Unfold the handle as below picture show Fig.4, choose a position(3 holes position Fig.5) to fix the Inferior handle(4) with bolt and nuts on both side.(Fig.6 & 7)
- 3) Fix tightly the preassembly nuts on both side of Inferior handle(4).
- 4) Fix the superior handle(3) with the quick release nuts on both side(Fig.8)



Fig.4



Fig.5



Fig.6



Fig.7



Fig.8

4.2 ASSEMBLY OF TOOLS BOX

Put the tools box on superior handle(3) and alignment to the assembly holes, fix the box with bolt and nuts on both side.(Fig.9,10,11,12,13)
 Fetter the cable with the cable clamp(Fig.14)



Fig.9



Fig.10



Fig.11



Fig.12



Fig.13



Fig.14

4.3 ASSEMBLY OF GRASS BAG

For rear discharge with grass collection.(Fig.19)

- 1) Pull up the deflector and take out the mulcher guard if there it is(Fig.15)
- 2) Pull up the deflector and place the grass catcher at its place.(Fig.16& 17)
- 3) Keep the side discharge is closed.(Fig.18)
- 4) Take out the garss catcher, grass rear discharged without grass collection.(Fig.20)



Fig.15



Fig.16



Fig.17



Fig.18

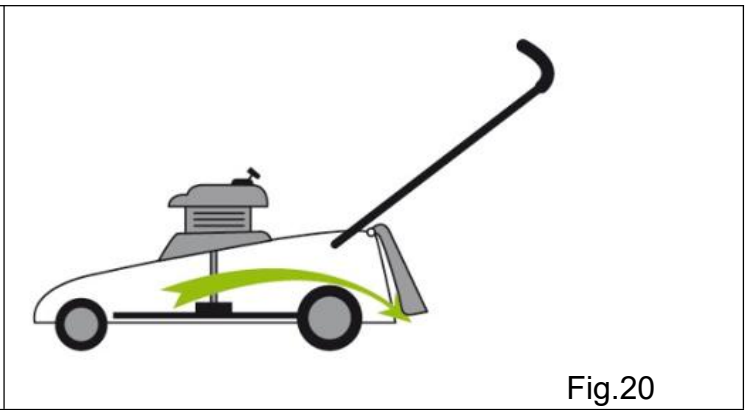
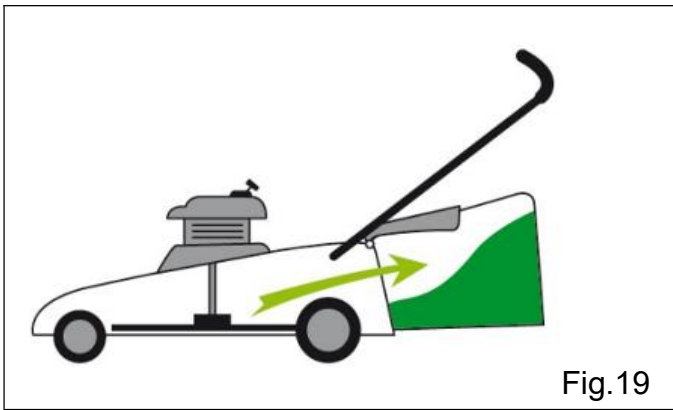

4.3 ASSEMBLY OF SIDE DISCHARGE

For grass side discharge function(Fig.26)

- 1) Take out the grass catcher and put the mulcher guard in place(Fig.21), keep the deflector closed.(Fig.22)
- 2) Pull the unlock device to open the side discharge cover.(Fig.23 & 24)
- 3) Put the side discharge guiding board at it's correct place.(Fig.25)





Fig.25

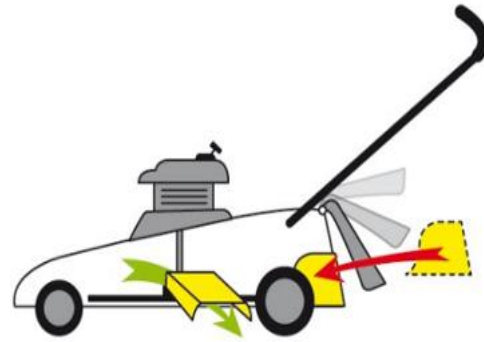

Fig.26

4.4 ASSEMBLY OF MULCHING GUARD

For grass mulching function.(Fig.30)

- Take out the grass catcher and insert the Mulcher Guard in its correct position.(Fig.27)
- Keep the deflector is closed.(Fig.28)
- Keep the side discharge is closed.(Fig.29)



Fig.27



Fig.28



Fig.29

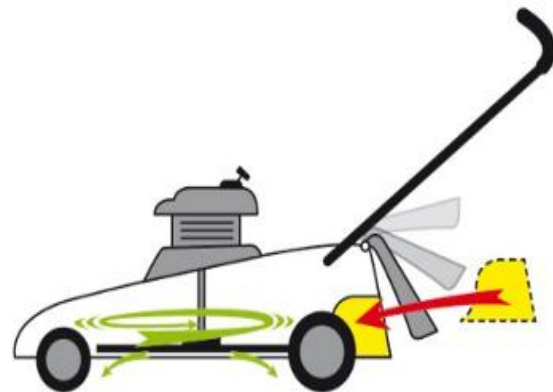

Fig.30

5. FILLING FUEL AND OIL TANK

WARNING! Gasoline is extremely flammable.

Store fuel in specially designed cans for this purpose.

Fill the fuel tank only outdoors and before starting the engine. Do not smoke when filling the fuel tank or handling fuel.

Never open the fuel tank cap and never add fuel while the engine is running or when it is hot.

If fuel has spilled, do not start the engine any further, move the tool away from where the fuel has been spilled, and be careful not to create a spark or flame until the fuel vapours have dissipated.

Fully close all fuel tank and fuel canisters.

Before tilting the mower to maintain the blade or drain the oil, empty the fuel tank.

WARNING: Never fill the fuel tank indoors, while the engine is running, or before the engine has cooled down for at least 15 minutes after use.

CAUTION: Do not use unapproved gasoline, such as E15 and E85. Do not mix the oil with gasoline or modify the engine to operate with alternative fuels. The use of unapproved fuels will damage the engine parts and will void the engine warranty. To protect the fuel system from scale formation, add a fuel stabilizer to the fuel. All fuels are not identical. If start-up or performance problems occur, change supplier or fuel brand.

5.1 FILLING TANK

Fuel must meet the following criteria:

- Clean, new, and lead-free gasoline. (**max.capacity 800ml**)
- A minimum octane rating of 87/87 AKI (91 RON). For use at high altitudes, see below
- A gasoline containing up to 10% ethanol is acceptable.
- Remove the fuel tank cap. Add fuel.
- Close the fuel tank with the cap.

Do not overfill. Wipe off any fuel that has overflowed before starting the engine.

5.2 ENGINE OIL

Recommended oil: We recommend the use of high-quality detergent oil classified for SF, SG, SH, SJ or higher. Do not use special additives.

Filling oil tank (**max.capacity 400ml**)

- Open the oil tank.
- Directly fill the oil in the tank. Do not overfill.
- Close the oil tank. Wipe any spillage.

Checking the oil level

- Check the oil level when the engine is off and horizontal.
- Remove the plug / dipstick from the oil tank and wipe it off.
- Insert the oil tank plug / dipstick into the tank neck as shown, without screwing it in, and then remove it to check the oil level.
- If the oil level is near or below the lower limit of the dipstick, remove the dipstick and fill the recommended oil reservoir up to the upper limit of the dipstick (bottom edge of the dipstick). Do not overfill.
- Replace the oil tank plug / dipstick.



L: Lower limit / H: upper limit

⚠ WARNING! Engine delivered without oil: add 450ml engine oil before starting the engine.

6. OPERATION

6.1 SAFETY PRECAUTIONS

- Always use the lawnmower with the grass catcher or/ and the deflector in position.
- Stop the engine before emptying the grass catcher or before you change the cutting height.
- While the engine is running, never introduce your hands or feet under the lawnmower or under the grass ejection area. Fig. C
- Before mowing, remove all foreign objects from the lawn, which maybe thrown by the machine. Fig. D
- Keep children and other people and domestic animals at a safe distance when the lawnmower is in use.
- Never lift the mower while starting the engine. Fig. E

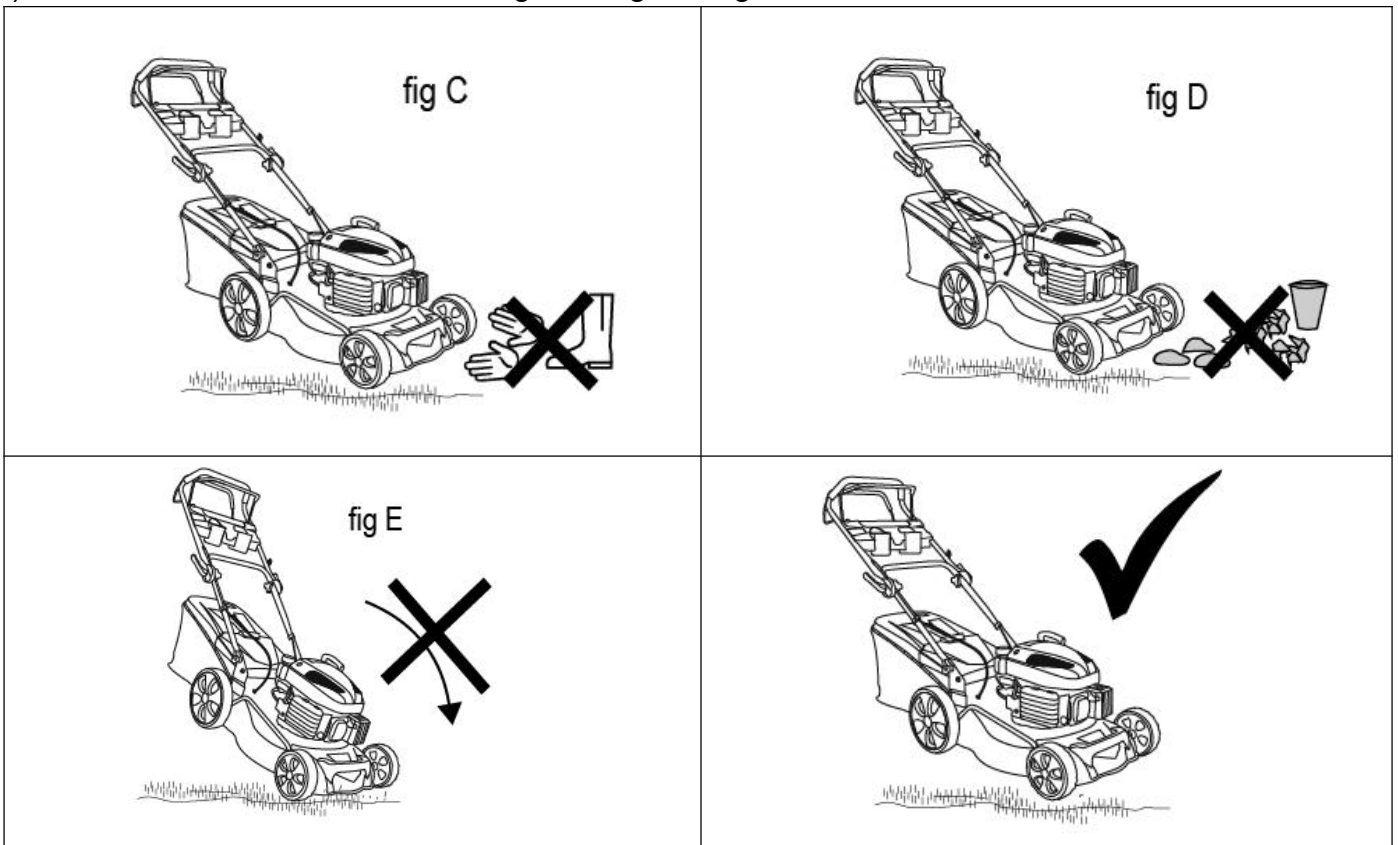

6.2 CUTTING HEIGHT ADJUSTMENTS

- One central height adjustment: 8 positions.
- Move the handle to change the height setting between 25-75mm.



6.3 ENGINE STARTING

COLD STARTING

- a) Press the primer bulb 3 - 5 times



- b) Pull engine control lever until it touches the upper handle.



- c) Pull the starter rope until the engine starts.



HOT-STARTING THE ENGINE

- d) Pull Engine control lever until it touches the upper handle.
e) Pull the starter rope until the engine starts.

STOP THE ENGINE

Release the Engine control lever



Warning! Blade is in action as soon as engine started. While the machine is working maintain the engine control lever (2) in working position. The engine will stop as soon as you release the engine control bar(2).

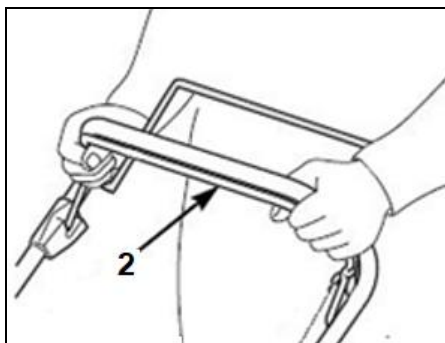

6.4 FOR THE SELF-PROPELLED MOWER

To engage the self-propelled system, pull on the self-propelled lever(1) and maintain it engaged together with the handle.

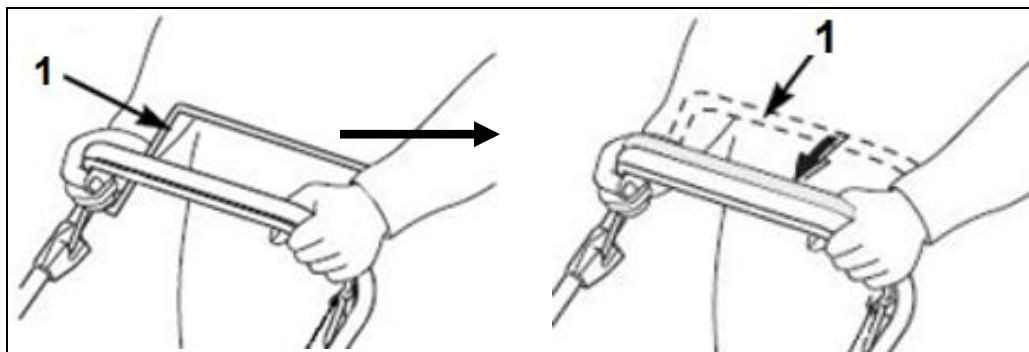

6.5 GEAR BOX

Control frequently the self-propelled system. Polish the gear in the wheels and put grease on them. Do the same control on the ball bearing if any.

6.6 SECURITY MEASURES

General conditions of use.

1. This machine is to be used exclusively for cutting natural grass. Never use the mower for other purposes. Any other utilization can involve danger for your safety and can involve damage to the mower.
2. Persons under 16 years of age and persons who are not familiar with the user instructions must not use the mower.
3. The user is responsible of the safety of other people in the working area. Keep children and domestic animals at a safe distance while the mower is in use.
4. Before mowing, remove all foreign object from the lawn which may be thrown by the machine, stay alert for any foreign objects which may have been missed.

6.7 USING INSTRUCTIONS

1. Check that all nuts, bolts and screws are well tightened.
2. Before mowing place the grass catcher in its position.
3. Before mowing make sure that the blade and the blade fixing screw are securely fastened. When cutting edges require resharpening, this must be done evenly on both sides so as to prevent any imbalance. If the blade is damaged, it must be replace.
4. When mowing always wear a long trousers and strong footwear.
5. Do not run the engine in an enclosed and/or poorly ventilated area, where gas of the engine contains carbon monoxide, which are dangerous for your health.
6. Work only when there is sufficient light.
7. Do not use the lawnmower when it is raining or when the grass is wet.

8. Particular precautions must be taken while mowing on slopes or downing stretches. Mow across the face of slopes, never down or up.
9. Turn off the engine if you must leave the lawnmower unattended, displace the lawnmower or incline it.
10. Never lift the rear of the mower while starting the engine and never place your hands and feet underneath the deck or into the rear discharge chute while the engine is running.
11. Never change in any way the rated speed of the engine.
12. On the self-propelled mowers, disconnect the self-propelled system before starting the engine.
13. Never lift or carry the mower while the engine is running.
14. Stop the engine and remove the spark plug cover in these cases:
 - Before any operation under the deck or the grass rear discharge chute.
 - Before any maintenance, repairing or checking operations.
 - Before carrying, lifting or removing the mower.
 - If you leave the mower unattended or changing the cutting height.
 - To remove and emptying the grass catcher.
 - After hitting a foreign object, stop the engine and check thoroughly the mower in order to see if it is damage. Bring the mower in a agreed service station to do the repairing if necessary.
 - **WARNING:** After you stopped the engine the blade is still in motion during a few seconds.
 - If the mower vibrates in an abnormal way, find the reasons why, and take your mower to an agreed service station.
 - Check regularly that bolts, nuts and screw are secularly tightening for a safe use of the mower.
15. **WARNING: GASOLINE IS HIGHLY INFLAMMABLE.**
 - Keep gasoline in a jerry can specially made for this purpose.
 - Fill up the tank with a funnel, do the operation outside. Do not smoke. Do not use mobile phone.
 - Fill up with gasoline and oil before staring the engine. Never open the cap of the fuel tank to add gasoline while the engine is running or still hot.
 - Do not start the engine if there is some gasoline spread around, take the mower away from the one where gasoline have been split and avoid any contact from a hot source as long as the split gasoline is completely eva0porated.
 - Tighten the fuel tank cap and close tightly the jerry can cap.

7. MAINTENANCE AND STORAGE

Before working on the cutting system of the machine, switch off the engine and remove the spark plug's cap.

WARNING - Improper maintenance, use of nonconforming replacement components, or the removal or modification of safety components can cause accidents and the deterioration of the tool.

a. Cleaning the mower

- Cut grass is damp. Regular cleaning after each use will ensure better functioning of the mower and reduce the risk of corrosion or seizure.
- Having finished mowing, allow the engine to cool then remove accumulated grass clippings from and around the engine with a brush.
- Clean the grass collection bag annually with a brush or gentle spray of water.
- Disconnect the spark plug's cap and tilt the mower on its side with the air filter and carburettor uppermost.
- Remove any remaining cut grass from the cutting system with a scraper and a brush.

- Reposition the mower onto its four wheels.
- Do not use a pressure washer or hot water to clean the mower. Be careful to avoid soaking parts such as the engine, air cleaner, wheel bearings and metal fastenings. Dry off the machine before storing by leaving it running for a few minutes on a flat, clear surface to prevent corrosion or seizure.
- This machine equipped with a standard joint on steel deck, for water connection to clean the deck after each use.

b. Blade maintenance



WARNING: Wear gloves, turn off the engine and remove the spark plug before proceeding.

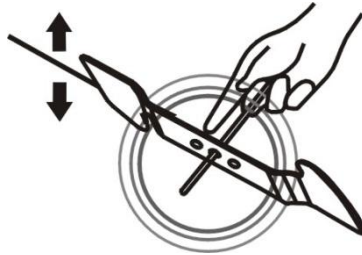

The blade is made of hardened steel. To get a clean job, sharpen the blade frequently, about every 25 hours of use. Make sure the blade is always well balanced.

Insert a small iron pin (2 or 3 mm in diameter) into the hole in the middle of the blade: it must remain horizontal. If the blade does not stay horizontal, balance it by sharpening it further on the side where it is leaning.



WARNING: Use only original spare parts. Poor quality replacement parts can cause serious damage to your mower and affect your safety.

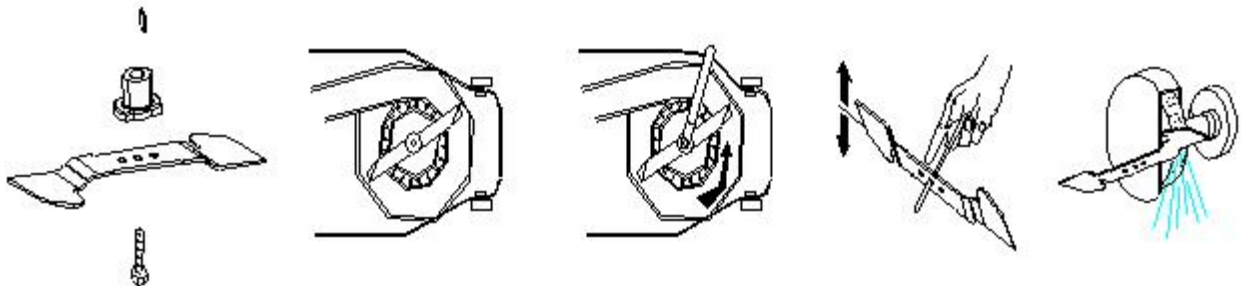

To remove the blade, loosen the screw, check the blade bracket, and replace all parts if they are worn or damaged.

When reassembling the blade, make sure that the cutting edges are in the same direction as the direction of rotation of the motor. The tightening torque of the blade screw should be $3.7 \text{ kg} \cdot \text{m/s}^2$ (37 N.m) and can be checked with a torque wrench.

c. Storing the mower

Store your mower in a dry, well-ventilated area, away from flames, sparks or heat sources. If the storage area is accessible to children, immobilise the machine by disconnecting the spark plug's cap. Storing the mower beneath a tarpaulin or similar cover is not recommended as it may cause a build - up of condensation resulting in corrosion of the mower.

Vertical storage

This machine can be stored vertically:

- Adjust the cutting height to the highest position.(Fig.31)

- Disassemble the nuts/bolts(1) on both side of the Inferior handle.(Fig.32)
- Loose the nuts(2) on both side of the Inferior handle but not disassembly completely.(Fig.32)
- Fold the handle as show in below (Fig.33)



Fig.31

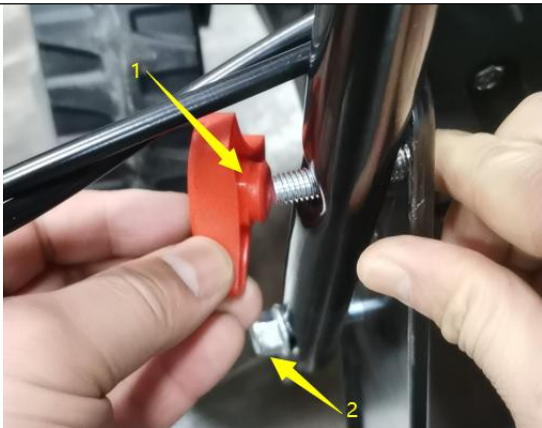

Fig.32



Fig.33

Extended shutdown and winter storage

Thoroughly clean the mower. Ideally, run the engine outdoors until the fuel tank is empty. Alternatively, empty any remaining fuel using a fuel suction pump.

Dispose of discarded fuel safely and responsibly, remembering that petrol vapours can cause explosion or fire. Run the engine until any remaining fuel is consumed. Allow the engine to cool. Check the condition and cleanliness of the air cleaner. Remove the spark plug from the engine and pour a tablespoon of engine oil into the cylinder. Gently pull the starter rope several times to turn over the engine, distributing the oil to protect the cylinder over winter. Replace and tighten the spark plug.

At the start of the new season

Remove the spark plug and gently clean off any carbon deposits from the tip with a small copper wire brush, finishing off with petrol. Allow the spark plug to dry. Pull the starter rope several times to expel excess oil from the cylinder. Replace and tighten the spark plug. Fill the fuel tank with unleaded petrol. Turn over the engine until it starts.

Before transporting the mower

Thoroughly clean the mower. Empty the fuel tank using a suction pump. Dispose of discarded fuel safely and responsibly, remembering that petrol vapours can cause explosion or fire. Run the engine until any remaining fuel is consumed.

Allow the engine to cool. Remove the grass collection bag. Loosen the quick release and fold down the top section of the handles taking care not to bend the cables.

To avoid scratching the mower, insert corrugated cardboard or similar padding between the upper and lower handlebars and the engine.

Due to the mower's weight, use ramps or seek assistance when lifting or loading the mower.

d. Mower maintenance

Cutting system

Before and after each mowing session, check that the blade, its attachment bolts and drive shaft are not damaged or excessively worn. Never try to straighten a bent blade. Replace a damaged, worn or bent blade as soon as possible. Use only genuine parts. Excessive vibration when mowing is a good indication of a problem with the cutting system.



WARNING: Vibration from a bent or damaged blade can cause costly damage to the mower. Working with an excessively worn blade wastes fuel and can lead to injury if the blade becomes detached from the machine.

Sharpening the blade

For best mowing results, have the edges sharpened and the blade balanced at least once a year by a specialist service dealer or agent.

Spark plug

Check the spark plug initially after the first five hours of mower use. Thereafter, maintenance of the spark plug should take place every 25 hours.

Remove the spark plug cap using a rotary motion and then remove the spark plug with the wrench provided.

Clean off any carbon deposits using a copper brush and check the electrode gap with a feeler gauge.

Replace and retighten the serviced spark plug and replace the cap.

If the spark plug is worn or damaged, replace with a new spark plug of the same or suitable type for the engine.

Air Filter

An air filter in poor condition will reduce the performance and life of the engine while making it harder to start. Regular checks are therefore essential, especially when using the mower in dusty conditions.

Check and clean the air filter every 25 hours of use or more often if the engine is used in a dusty environment.

Remove the air box lid and carefully remove the foam filter cartridge. Clean the cartridge in a small bowl of warm water containing a few drops of washing up liquid until it is perfectly clean and free from all traces of grease and dust. Rinse the filter cartridge in clean water and then squeeze gently to remove most of the water. Let it air dry until it is completely dry.



WARNING: Never clean the foam cartridge in petrol, white spirit or other solvents. These products will degrade the filter cartridge.

Clean the cover and inside of the air box with a clean lint - free cloth. Apply a uniform layer of oil to the outside of the cartridge filter with a brush (you can use clean engine oil for this). Insert the filter cartridge into its housing and replace the air box lid, ensuring that each component is in place and properly installed. If the filter cartridge is damaged or is very dirty, replace it using a genuine part.



WARNING: Do not twist the cartridge to clean foam, as you could damage it. This mower is equipped with a dual filtration system comprising a foam pre - filter and a cartridge filter paper.

The maintenance of a foam pre - filter is identical to that of a foam cartridge filter, as described above. The cartridge filter paper should be cleaned with a vacuum cleaner. If it is dirty or contaminated with oil or petrol, replace it.

Clean the cover and inside of the air box with a clean cloth. Evenly apply a thin layer of oil to the outside of the cartridge filter with a brush (you can use clean engine oil for this). Replace the filter cartridge in its housing and then replace the lid of the air box, ensuring that each component is in place and properly installed.

8. TROUBLESHOOTING

PROBLEM	CAUSE	SOLUTION
Engine runs roughly	Choke in the wrong position.	Move choke lever to the RUN position.
	Dirty air filter.	Clean or replace with a new one.
	Dirty fuel valve.	Clean the fuel valve.
Engine stops suddenly	Low oil level.	Fill engine oil to proper level.
	Empty fuel tank or wrong fuel type.	See ENGINE OIL AND FUEL.
	Wrong fuel tank cap.	Replace fuel cap.
	Disconnected spark plug cap.	Secure spark plug cap.
Engine stops under heavy load	Dirty air filter.	Clean or replace with a new one.
	Engine running cold.	Allow engine warms up before operation.
Engine knocks	Engine overloaded.	Do not exceed rating load.
	Wrong fuel type.	See ENGINE OIL AND FUEL
Engine backfires	Impure gasoline or wrong fuel type.	Drain the old fuel and refill with fresh gasoline. See ENGINE OIL AND FUEL.
	Intake valve stuck or overheated engine.	Have a qualified technician diagnose the engine.
Engine overheated	Incorrect timing.	Check engine timing.
	Low engine oil level.	Add engine oil to proper level.
	Clogged exhaust pipe.	Clean exhaust pipe.
Blade does not turn	Cooling fan blocked.	Clean cooling fan.
	Blocked with grass.	Remove the grass(see)
	Blade not installed correctly.	Check the blade and install it correctly.
Abnormal noises and vibration	Blade not installed correctly.	Check the blade and install it correctly.
	Blade damaged.	Remove the damaged blade and install a new one(See REPLACE THE BLADE).
Other	Contact an authorized service dealer for technical support.	

9. DECLARATION OF CONFORMITY



BUILDER SAS

**32 rue Aristide Bergès - Z.I. du Casque - 31270 Cugnaux - France
Tel. +33 (0) 5.34.502.502 Fax: +33 (0) 5.34.502.503**

Declares that the machine named below

Petrol lawn mower

FTDT5124VS

Serial number: 20240123770-20240123839
20240124140-20240124209

Complies with the following European Directives:

Machinery Directive 2006/42/EC

EMC Directive 2014/30/EU

Emission Regulation (EU) 2016/1628,
as last amended by Regulation (EU) 2018/989

Applicable harmonized standards:

EN ISO 12100:2010

EN ISO 5395-1: 2013+A1:2018

EN ISO 5395-2: 2013+A1:2016+A2:2017

EN ISO 14982: 2009

Other applicable guidelines:

Noise Directive 2000/14/EC amended by 2005/88/EC, Annex VI

Guaranteed Sound Power Level	98dB(A)
Sound power level	L _{wA} : 94.9dB(A) K= 2.14dB(A)

EU type-approval No: e24*2016/1628*2018/989SRA1/P*0456*00

Cugnaux, 15/01/2024

Philippe MARIE / CEO

Responsible of technical file: M. Olivier Patriarca

10. WARRANTY



WARRANTY

The manufacturer guarantees the product against defects in material and workmanship for a period of 2 years from the date of the original purchase. The warranty only applies if the product is for household use. The warranty does not cover breakdowns due to normal wear and tear.

The manufacturer agrees to replace parts identified as defective by the designated distributor. The manufacturer does not accept responsibility for the replacement of the machine, in whole or in part, and/or ensuing damage.

The warranty does not cover breakdowns due to:

- insufficient maintenance.
- abnormal assembly, adjustment or operations of the product.
- parts subject to normal wear and tear.

The warranty does not extend to:

- shipping and packaging costs.
- using the tool for a purpose other than that for which it was designed.
- the use and maintenance of the machine done in a manner not described in the user manual.

Due to our policy of continuous product improvement, we reserve the right to alter or change specifications without notice. Consequently, the product may be different from the information contained therein, but a modification will be undertaken without notice if it is recognized as an improvement of the preceding characteristic.

READ THE MANUAL CAREFULLY BEFORE USING THE MACHINE.

When ordering spare parts, please indicate the part number or code, you can find this in the spare parts list in this manual. Keep the purchase receipt; without it, the warranty is invalid. To help you with your product, we invite you to contact us by phone or via our website:

- **+33 (0)9.70.75.30.30**
- **<https://services.swap-europe.com/contact>**

You must create a "ticket" via the web platform.

- Register or create your account.
- Indicate the reference of the tool.
- Choose the subject of your request.
- Describe your problem.
- Attach these files: invoice or sales receipt, photo of the identification plate (serial number), photo of the part you need (for example: pins on the transformer plug which are broken).



11. PRODUCT FAILURE

WHAT TO DO IF MY MACHINE BREAKS DOWN?

If you bought your product in a store:

- a) Empty the fuel tank if your product has one.
- b) Make sure that your machine is complete with all accessories supplied, and clean! If this is not the case, the repairer will refuse the machine.

Go to the store with the complete machine and with the receipt or invoice.

If you bought your product on a website:

- a) Empty the fuel tank if your product has one.
- b) Make sure that your machine is complete with all accessories supplied, and clean! If this is not the case, the repairer will refuse the machine.
- c) Create a SWAP-Europe service ticket on the site: <https://services.swap-europe.com> When making the request on SWAP-Europe, you must attach the invoice and the photo of the nameplate (serial number).
- d) Contact the repair station to make sure it is available before dropping of the machine.

Go to the repair station with the complete machine packed, accompanied by the purchase invoice and the station support sheet downloadable after the service request is completed on the SWAP-Europe site

For machines with engine failure from manufacturers BRIGGS & STRATTON, HONDA and RATO, please refer to the following instructions.

Repairs will be done by approved engine manufacturers of these manufacturers, see their site:

- <http://www.briggsandstratton.com/eu/fr>
- <http://www.honda-engines-eu.com/fr/service-network-page;jsessionid=5EE8456CF39CD572AA2AEEDFD290CDAE>
- <https://www.rato-europe.com/it/service-network>

Please keep your original packaging to allow for after-sales service returns or pack your machine with a similar cardboard box of the same dimensions.

For any question concerning our after-sales service you can make a request on our website <https://services.swap-europe.com>

Our hotline remains available at +33 (9) 70 75 30 30.



12. WARRANTY EXCLUSIONS

THE WARRANTY DOES NOT COVER:

- Start-up and setting up of the product.
- Damage resulting from normal wear and tear of the product.
- Damage resulting from improper use of the product.
- Damage resulting from assembly or start-up not in accordance with the user manual.
- Breakdowns related to carburetion beyond 90 days and fouling of carburetors.
- Periodic and standard maintenance events.
- Actions of modification and dismantling that directly void the warranty.
- Products whose original authentication marking (brand, serial number) has been degraded, altered or withdrawn.
- Replacement of consumables.
- The use of non-original parts.
- Breakage of parts following impacts or projections.
- Accessories breakdowns.
- Defects and their consequences linked to any external cause.
- Loss of components and loss due to insufficient screwing.
- Cutting components and any damage related to the loosening of parts.
- Overload or overheating.
- Poor power supply quality: faulty voltage, voltage error, etc.
- Damages resulting from the deprivation of enjoyment of the product during the time necessary for repairs and more generally the costs related to the immobilization of the product.
- The costs of a second opinion established by a third party following an estimate by a SWAP-Europe repair station
- The use of a product which would show a defect or a breakage which was not the subject of an immediate report and/or repair with the services of SWAP-Europe.
- Deterioration linked to transport and storage*.
- Launchers beyond 90 days.
- Oil, petrol, grease.
- Damages related to the use of non-compliant fuels or lubricants.

* In accordance with transport legislation, damage related to transport must be declared to carriers within 48 hours maximum after observation by registered letter with acknowledgement of receipt.

This document is a supplement to your notice, a non-exhaustive list.

Attention: all orders must be checked in the presence of the delivery person. In case of refusal by the delivery person, it you must simply refuse the delivery and notify your refusal.

Reminder: the reserves do not exclude the notification by registered letter with acknowledgement within 72 hours.

Information:

Thermal devices must be wintered each season (service available on the SWAP-Europe site). Batteries must be charged before being stored.

FEIDER

MACHINES



BUILDER SAS
32, rue Aristide Bergès - ZI 31270 Cugnaux – France
Made in PRC